

**GENERAC®**  
Portable Products

# 2400PSI

## *High Pressure Washer Owner's Manual*



**Problems?  
Questions?**  
Before taking your unit  
back to the store,  
call the pressure washer  
helpline at  
**1-800-270-1408**  
**M-F 8-5 CT**



Model No. 1440-0 (2,400 PSI High Pressure Washer) Manual No. B5740 Revision 2 (9/11/2000)

Visit our Generac website: [www.generac-portables.com](http://www.generac-portables.com)



This is the safety alert symbol. It is used to alert you to potential personal injury hazards. Obey all safety messages that follow this symbol to avoid possible injury or death.



## EQUIPMENT DESCRIPTION

**CONGRATULATIONS** on your purchase of a GENERAC high pressure washer. It has been designed, engineered and manufactured to give you the best possible dependability and performance.

This manual contains information for a high pressure washer that operates at 2,400 PSI at a flow rate of 2.2 gallons per minute. This high quality residential system features large 10" wheels, brass pump head construction, axial cam pump with stainless steel pistons, automatic cool down system, chemical injection system, adjustable spray nozzle. Includes safety goggles, heavy duty 25' hose, and more.

Please read and retain this manual. The instructions will enable you to assemble your unit without tools, and maintain your high pressure washer properly.

Every effort has been made to ensure that the information in this manual is both accurate and current. However, Generac reserves the right to change, alter or otherwise improve the product and its documentation at any time without prior notice.

Should you experience any problem you cannot easily remedy, call the pressure washer helpline at **1-800-270-1408**.

## CUSTOMER RESPONSIBILITIES

- Read and observe the safety rules.
- Follow regular schedule in maintaining, caring for and using your high pressure washer.
- For off-season storage, review "Preparing the Unit for Storage" on page 14.



## SAFETY RULES

 **CAUTION!** When setting up, transporting, adjusting or making repairs to your high pressure washer, always disconnect the spark plug wire from the spark plug and place the wire where it cannot contact spark plug.

 **DANGER!** Engine exhaust gases contain DEADLY carbon monoxide gas. This dangerous gas, if breathed in sufficient concentrations, can cause unconsciousness or even death. Operate this equipment only in the open air where adequate ventilation is available.

 **DANGER!** Gasoline is highly FLAMMABLE and its vapors are EXPLOSIVE. **Do Not** permit smoking, open flames, sparks or heat in the vicinity while handling gasoline. Avoid spilling gasoline on a hot engine. Allow unit to cool for 2 minutes before refueling. Comply with all laws regulating storage and handling of gasoline.

**Read this manual carefully and become familiar with your pressure washer. Know its applications, its limitations, and any hazards involved.**

	<b>WARNING:</b>	
<b>The engine exhaust from this product contains chemicals known to the State of California to cause cancer, birth defects, or other reproductive harm.</b>		

- Locate this pressure washer in areas away from combustible materials, combustible fumes or dust.
- The high pressure equipment is designed to be used with Generac authorized parts only. If you use this equipment with parts that do not comply with minimum specifications, the user assumes all risks and liabilities.
- Some chemicals or detergents may be harmful if inhaled or ingested, causing severe nausea, fainting or poisoning. The harmful elements may cause property damage or severe injury.
- **Do Not** allow CHILDREN to operate the pressure washer at any time.



- Operate engine only at governed speed. Running the engine at excessive speeds increases the hazard of personal injury. **Do Not** tamper with parts which may increase or decrease the governed speed.
  - **Do Not** wear loose clothing, jewelry or anything that may be caught in the starter or other rotating parts.
  - Before starting the pressure washer in cold weather, check all parts of the equipment and be sure ice has not formed there.
  - **Never** use a spray gun which does not have a trigger lock or trigger guard in place and in working order.
  - Keep the hose connected to machine or the spray gun while the system is pressurized. Disconnecting the hose while the unit is pressurized is dangerous.
  - **Never** operate units with broken or missing parts, or without protective housing or covers.
  - Check the fuel system for leaks or signs of deterioration, such as chafed or spongy hose, loose or missing clamps, or damaged tank or cap. Correct all defects before operating the pressure washer.
  - **Do Not** spray flammable liquids.
  - Use a respirator or mask whenever there is a chance that vapors may be inhaled. Read all instructions with mask so you are certain the mask will provide the necessary protection against inhaling harmful vapors.
  - **Never** aim the gun at people, animals or plants. The high pressure stream of water that this equipment produces can pierce skin and its underlying tissues, leading to serious injury and possible amputation.
  - **Never** allow any part of the body to come in contact with the fluid stream. **Do Not** come in contact with a fluid stream created by a leak in the high pressure hose.
  - Always wear eye protection when you use this equipment or when you are in the vicinity where the equipment is in use.
  - High pressure spray can cause paint chips or other particles to become airborne.
  - **Do Not** operate the pressure washer above the rated pressure.
  - **Never** move the machine by pulling on the high pressure hose. Use the handle provided on the unit.
  - Always be certain the spray gun, nozzles and accessories are correctly attached.
  - **Do Not** secure the spray gun in the (open) position.
  - High pressure spray may damage fragile items including glass. **Do Not** point spray gun at glass when in the jet spray mode.
  - Hold the spray gun firmly in your hand before you start the unit. Failure to do so could result in an injury from a whipping spray gun. **Do Not** leave the spray gun unattended while the machine is running.
  - The cleaning area should have adequate slopes and drainage to reduce the possibility of a fall due to slippery surfaces.
  - Keep water spray away from electric wiring or fatal electric shock may result.
  - **Do Not** by-pass any safety device on this machine.
  - The muffler and engine heat up during operation and remain hot immediately after shutting it down. Avoid contact with a hot muffler or engine as you could be severely burned.
  - Operate and store this unit on a stable surface.
  - High pressure hose can develop leaks from wear, kinking, abuse, etc. Water spraying from a leak is capable of injecting material into skin. Inspect hose each time before using it. Check all hoses for cuts, leaks, abrasions or bulging of cover, or damage or movement of couplings. If any of these conditions exist, replace hose immediately. **Never** repair high pressure hose. Replace it with another hose that exceeds maximum pressure rating of your unit.
  - The muffler and air cleaner must be installed and in good condition before operating the pressure washer. These components act as spark arresters if the engine backfires.
- In the State of California a spark arrester is required by law (Section 4442 of the California Public Resources Code). Other states may have similar laws. Federal laws apply on federal lands.
- NOTE:** If you equip the muffler with a spark arrester, it must be maintained in effective working order. You can order a spark arrester through your authorized Briggs and Stratton service dealer.



## KNOW YOUR PRESSURE WASHER

Read this owner's manual and safety rules before operating your high pressure washer.

Compare the illustrations with your high pressure washer to familiarize yourself with the locations of various controls and adjustments. Save this manual for future reference.

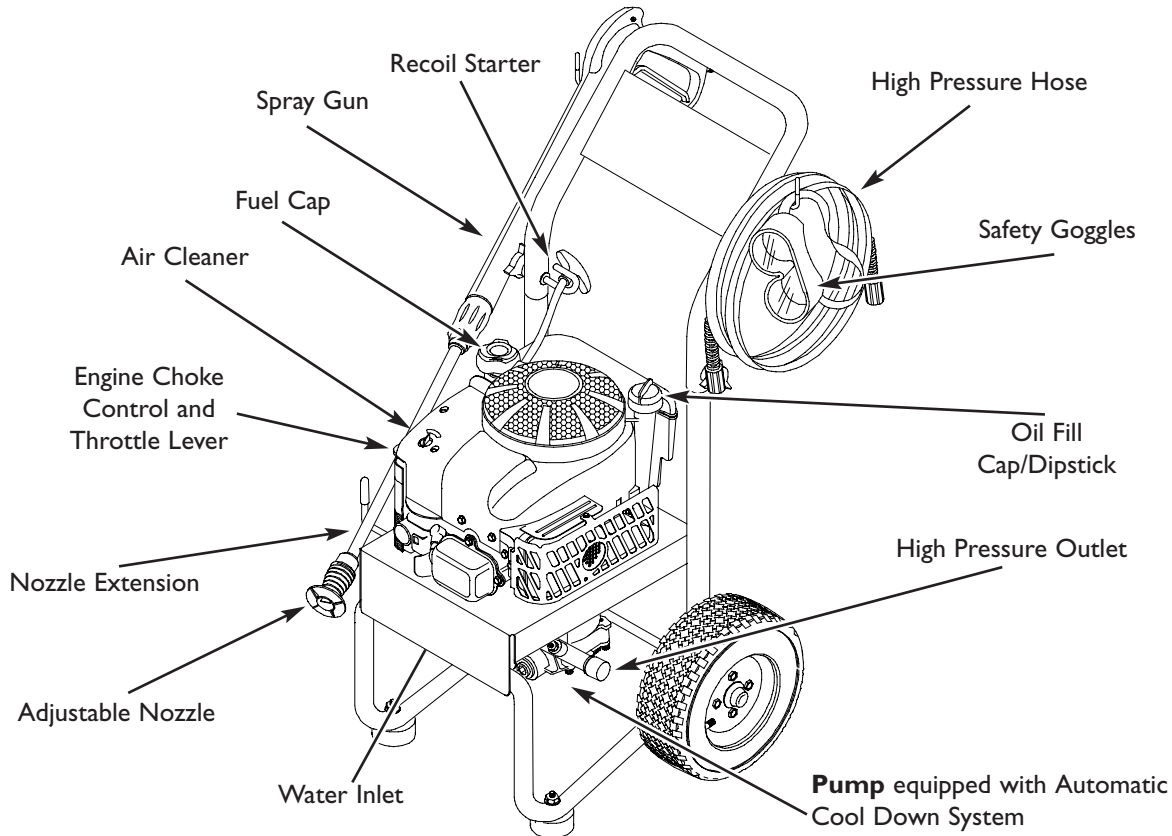

**Adjustable Nozzle** — Always attached to nozzle extension. Adjustable nozzle allows you to adjust force of spray and spray pattern.

**Air Cleaner** — Dry type filter element limits the amount of dirt and dust that gets in the engine.

**Automatic Cool Down System** — Cycles water through pump when water reaches 140°-145°F. **Warm water will discharge from pump onto ground.** This system prevents internal pump damage.

**Engine Choke Control** — Permits easier engine starting.

**Fuel Cap** — Fill with clean unleaded fuel here.

**High Pressure Hose** — Connect one end to water pump and the other end to spray gun.

**High Pressure Outlet** — Connection for pressure hose.

**Nozzle Extension** — Attach to spray gun to use adjustable nozzle.

**Oil Fill Cap/Dipstick** — Used for checking and adding oil.

**Pump** — Develops high pressure.

**Recoil Starter** — Used for starting the engine manually.

**Safety Goggles** — Always wear eye protection when operating pressure washer.

**Spray Gun** — Controls the application of water onto cleaning surface with trigger device. Includes safety latch.

**Throttle Lever** — Sets engine in starting mode for recoil starter and stops a running engine.

**Water Inlet** — Connection for garden hose.

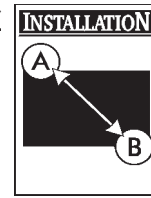

**WARNING!** Read entire owner's manual before you attempt to assemble or operate your new pressure washer.

## REMOVE PRESSURE WASHER FROM CARTON

- Remove the high pressure hose and parts box included with pressure washer.
- Slice two corners at the end of carton from top to bottom so the panel can be folded down flat, then remove all packing material.
- Roll pressure washer out of carton.

## CARTON CONTENTS

### Items in the carton include:

- Main Unit
- Parts Box (which includes the following):
  - Wireform
  - High Pressure Hose
  - Goggles
  - Handle Assembly
  - Handle Fastening Hardware
  - Nozzle Cleaning Kit
  - Owner's Manual
  - Engine Manual
  - Spray Gun
  - Nozzle Extension
  - Oil Bottle
  - O-ring Maintenance Kit

If any of the above parts are missing or damaged, call the pressure washer helpline at **1-800-270-1408**.

## PREPARING PRESSURE WASHER FOR USE

If you have any problems with the assembly of your pressure washer or if parts are missing or damaged, call the pressure washer helpline at **1-800-270-1408**.

**To prepare your pressure washer for operation, you will need to perform these tasks:**

- Attach the handle and wire form.
- Attach nozzle extension to spray gun.
- Connect the high pressure hose to the spray gun and the pump and connect the water supply to the pump.
- Add oil to the engine crankcase.
- Add fuel to the fuel tank.

### Attach Handle and Wire Form

**NOTE:** All assembly operations given in this section will be described from the perspective of assembling the pressure washer from the rear.

- Place the handle onto the handle supports already connected to the main unit. Make sure the holes in the handle align with the holes on the handle supports (Figure 1).

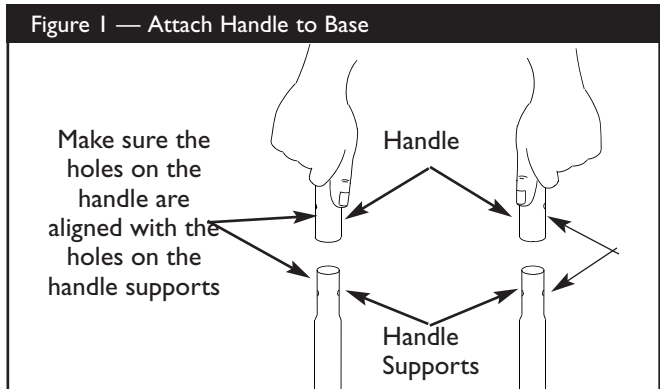

**NOTE:** It may be necessary to move the handle supports from side to side in order to align the handle so it will slide over the handle supports.

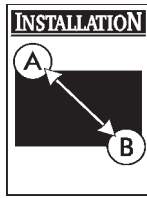

- Insert the carriage hook through the left hole (facing the front of the unit). Pull the recoil handle out of the engine slowly. Place the recoil string through the hook and attach the plastic knob. Tighten by hand (Figure 2).

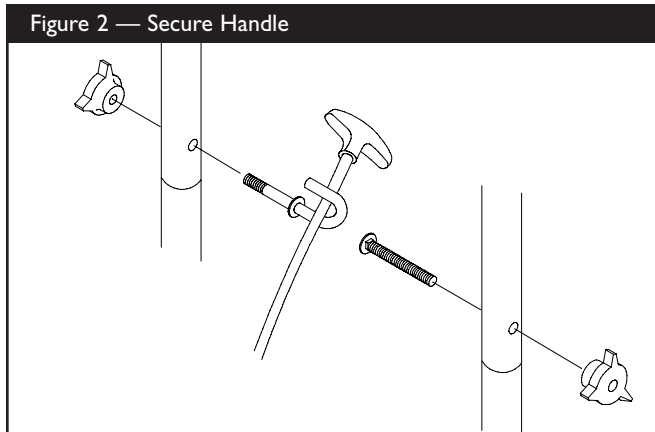

- Insert the carriage bolt through the right hole (facing the front of the unit) and attach a plastic knob. Tighten by hand (Figure 2).
- Insert the wire support with the longer arm positioned on the left. From the rear of unit, the hook should resemble a “J” (Figure 3).

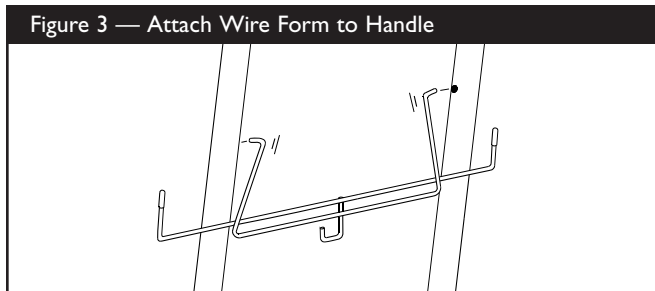

## Add Engine Oil

**IMPORTANT:** Any attempt to crank or start the engine before it has been properly serviced with the recommended oil may result in an engine failure.

- Place pressure washer on a level surface.
- Refer to engine owners manual to add recommended oil to engine.

**NOTE: Check Oil Often During Engine Break-in.**

## Add Gasoline

**DANGER!** Never fill fuel tank indoors. Never fill fuel tank when engine is running or hot. Do Not smoke when filling fuel tank.

**WARNING!** Never fill fuel tank completely full. Provide space for fuel expansion. Wipe away any fuel spillage from engine and equipment before starting.

- Use fresh, clean unleaded automotive gasoline and store in approved, clean, covered containers. Use clean fill funnels. Never use “stale” gasoline left over from last season or gasoline stored for long periods.
- Clean area around fuel fill cap, remove cap.
- Slowly add “UNLEADED” regular gasoline to fuel tank. Use a funnel to prevent spillage. Slowly fill tank to about 1/2” below the bottom of the filler neck (Figure 4).

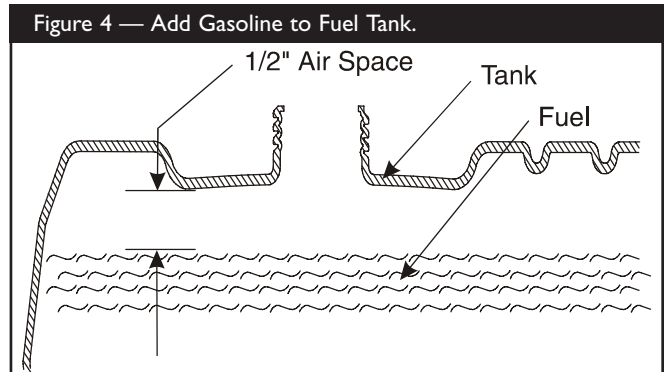

- Install fuel cap and wipe up any spilled gasoline.

## Connect Hose and Water Supply to Pump

**IMPORTANT:** You must attach all hoses before you start the engine. Starting engine without all hoses connected and water supplied will damage the pump.

- Uncoil the high pressure hose and attach one end of the hose to the base of the spray gun (Figure 5). Tighten by hand.



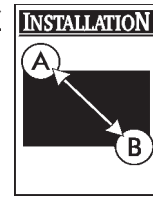
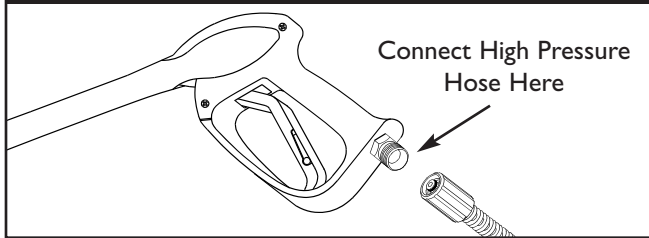
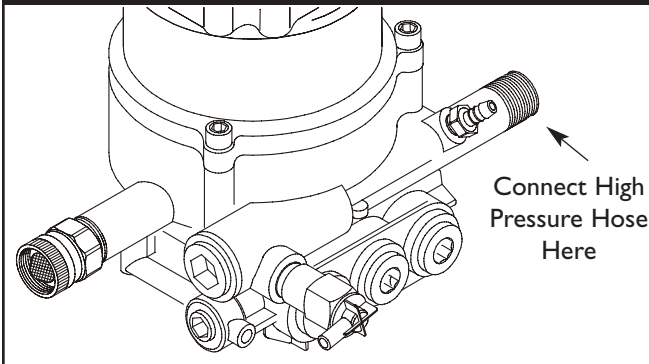

Figure 5 — Connect High Pressure Hose to Gun.



- Attach the other end of the high pressure hose to the high pressure fitting on the pump (Figure 6). Tighten by hand.

Figure 6 — Connect High Pressure Hose to Water Outlet.



- Before you connect your garden hose to the water inlet, inspect the inlet screen (Figure 7). Clean the screen if it contains debris, replace it if it is damaged. **DO NOT RUN THE PRESSURE WASHER IF THE SCREEN IS DAMAGED.**

Figure 7 — Connect Garden Hose to Water Inlet.

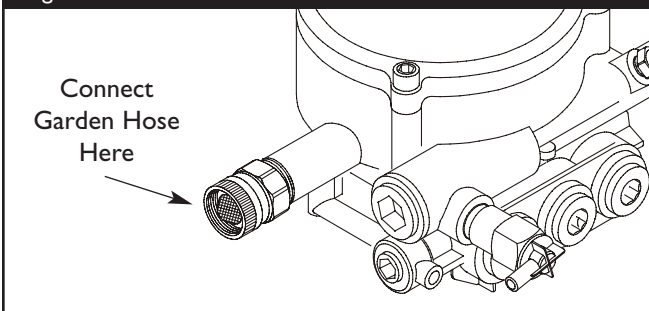

- Run water through your garden hose for 30 seconds to clean out any debris. Turn off water.
- Connect the garden hose to the water inlet. Tighten by hand (Figure 7).

**WARNING!** There **MUST** be at least ten feet of unrestricted garden hose between the pressure washer inlet and any flow shut off device, such as a 'Y' shut-off connector or other convenience-type water shut-off valve. Damage to pressure washer resulting from disregarding this warning will not be covered by the warranty.

- Turn **ON** the water.
- Squeeze the trigger on the gun until you have a steady stream of water. This purges the pump of air and impurities.

**CAUTION!** Before starting the pressure washer, be sure you are wearing adequate eye protection.

## CHECKLIST BEFORE STARTING ENGINE

Review the unit's assembly to confirm you have performed all of the following:

- Make sure the handle and wireform are in place and secure.
- Check that oil has been added to the proper level in the engine crankcase.
- Add the proper gasoline to fuel tank.
- Check for properly tightened hose connections.
- Check to make sure that there are no kinks, cuts, or damage to the high pressure hose.
- Provide a proper water supply (not to exceed 140°F) at an adequate flow.
- Be sure to read "Safety Rules" and "How To Start the Engine" before operating your pressure washer.



# HOW TO USE YOUR PRESSURE WASHER

If you have any problems operating your pressure washer, please call the pressure washer helpline at **1-800-270-1408**.

## How to Start Your Engine

The best way to start your engine-powered pressure washer for the first time is to follow these instructions step-by-step. You may also refer to your engine owner's manual. This starting information also applies whenever you start the engine after you have let the pressure washer sit idle for at least a day.

- Place the pressure washer in an area close enough to an outside water source capable of supplying water at a flow rate greater than 2.4 gallons per minute.
- Check that the high pressure hose is tightly connected to the spray gun and to the pump. See "Preparing Pressure Washer for Use" on page 5.
- Make sure unit is in a level position.
- Connect the garden hose to the water inlet on the pressure washer pump. **Turn ON the water.**

**CAUTION!** Do Not run the pump without the water supply connected and turned on. You must follow this caution or the pump will be damaged.

- Rotate the choke control to the "**CHOKE**" position (Figure 8).

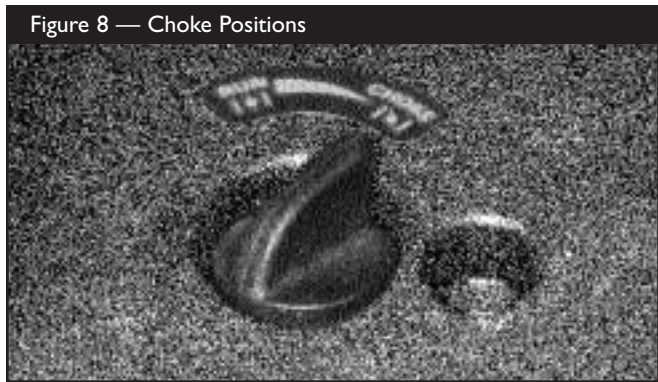

**NOTE:** For a warm engine, be sure the choke control is in the "**RUN**" position.

- Move throttle lever to "**Fast**" position, shown in Figure 9 as a rabbit. Always keep the throttle in the "**Fast**" position while pressure washing.

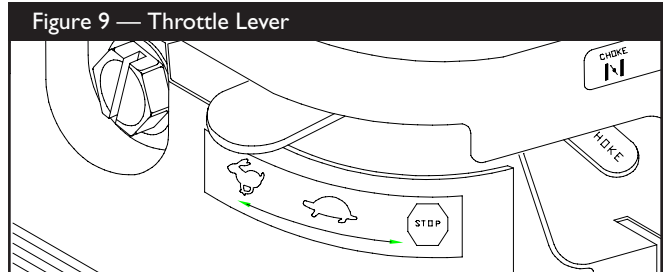

- Ensure the nozzle extension is **NOT** attached to the spray gun. Stand at the rear of the unit, as shown in Figure 10 (your unit will appear slightly different).







- Grasp the spray gun with your **left** hand and squeeze the trigger on the spray gun. Water will flow out of the spray gun in a thin stream. Continue to squeeze the trigger. Your left hand will also serve to steady the unit if you rest it on the handle, as shown.
- Grasp the recoil starter handle with your **right** hand and pull slowly until you feel some resistance. Then pull rapidly to start the engine.
- Return the starter grip handle slowly. **Do Not** let rope “snap back” against starter.
- If the choke control was placed in the “**Choke**” position to start the engine, move it slowly to the “**Run**” position as the engine warms up enough to run smoothly.
- If the engine fails to start, review instructions given in the engine owner’s manual.
- With the engine running, engage the safety latch to the spray gun trigger (Figure 11).

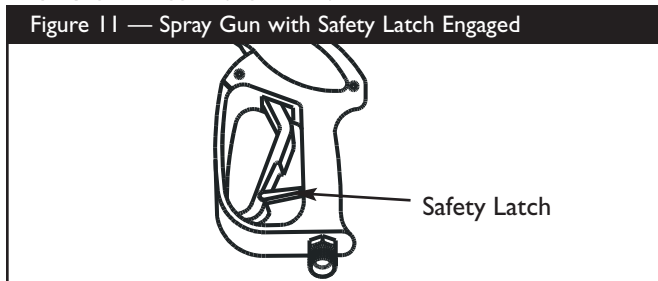

- Attach the nozzle extension to the spray gun. Tighten by hand (Figure 12).

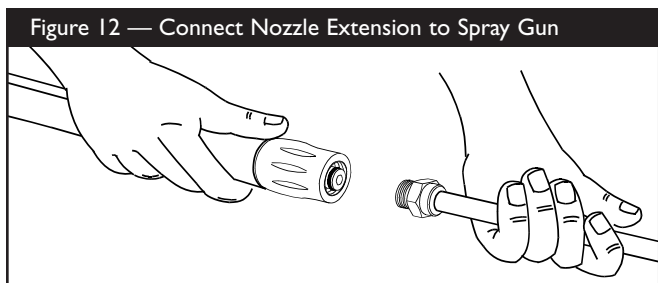

## How to Stop Your Pressure Washer

- Move throttle lever on engine to “**Stop**” position.
- **Squeeze trigger on the spray gun to relieve pressure in the hose.**

**NOTE:** A small amount of water will squirt out when you release the pressure.

## How to Use the Adjustable Nozzle

You now should know how to **START** your pressure washer and how to **STOP** it. The information in this section will tell you how to adjust the spray pattern and apply detergent or other cleaning chemicals.

**! DANGER!** Never adjust spray pattern when spraying. **Never** put hands in front of nozzle to adjust spray pattern.

On the end of your spray gun nozzle extension is a nozzle that permits you to adjust the spray pressure and pattern, as follows:

- Slide the nozzle forward to adjust the spray to low pressure mode, slide it backward to achieve high pressure (Figure 13).

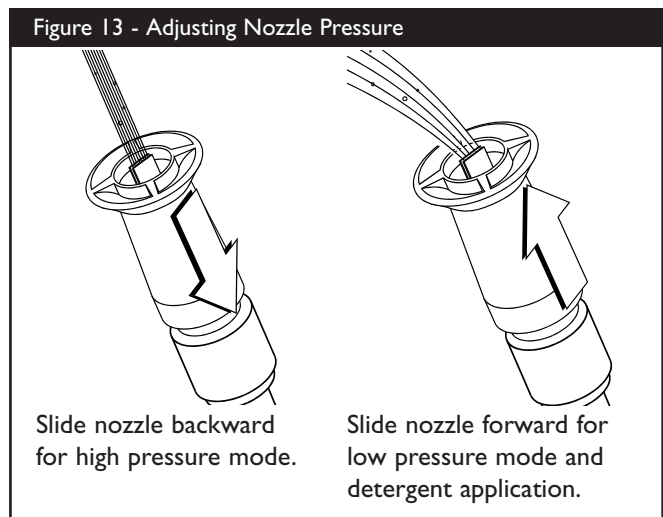



- Twisting the nozzle adjusts the spray pattern from a narrow pattern to a fan pattern (Figure 14).

Figure 14 - Adjusting Nozzle Spray Pattern

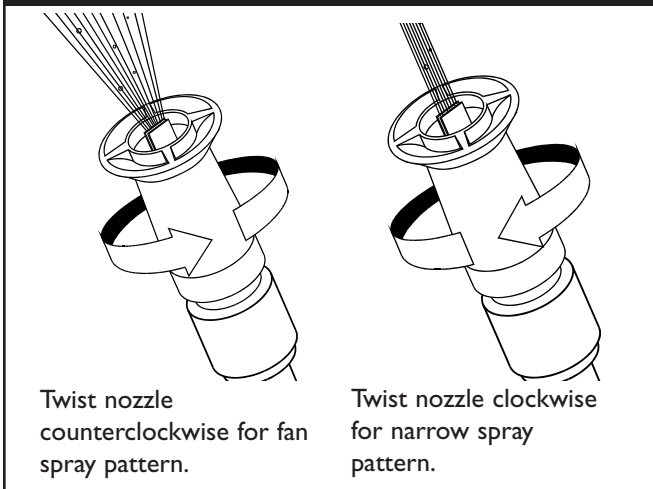

- Point the nozzle down toward a hard surface and press the trigger to test the pattern (Figure 15).

Figure 15 — Test the Spray Pattern.



- For most effective cleaning, keep the spray nozzle between 8 to 24 inches away from cleaning surface.
- If you get the spray nozzle too close, especially using high pressure mode, you may damage the surface being cleaned.
- **Do Not** get closer than 6 inches when cleaning tires.

## Applying Detergent with the Adjustable Nozzle

**IMPORTANT:** Use soaps designed specifically for pressure washers. Household detergents could damage the pump.

**IMPORTANT:** You must **attach all hoses** before you start the engine. Starting the engine without all the hoses connected and without the water turned ON will damage the pump.

**To apply detergent, follow these steps:**

- Review the use of the adjustable nozzle.
- Prepare detergent solution as required by the job.
- Hang the detergent solution on the hook of the wireform attached to the handle.
- Place the small filter end of the detergent siphoning tube into the detergent container (Figure 16).

Figure 16 — Insert Filter into Container.

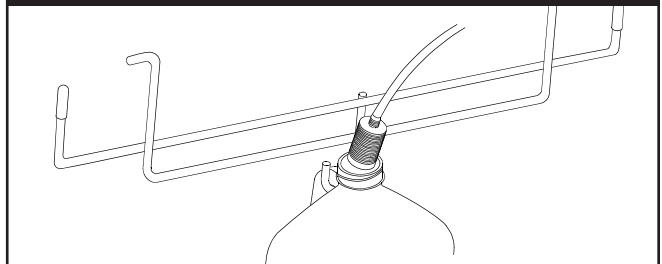

**CAUTION!** Keep the detergent siphoning tube from coming in contact with the hot muffler. This will damage the plastic tube. When inserting the filter into a cleaning solution bottle, route the tube so as to keep it from inadvertently contacting the hot muffler.

- Make sure the garden hose is connected to the water inlet. Check that the high pressure hose is connected to the spray gun and the pump.
- Start the engine, then attach the nozzle extension.
- Slide the adjustable nozzle forward to low pressure mode. Detergent cannot be applied with the nozzle in high pressure position.



- Apply detergent to a dry surface, starting from the bottom and working up.
- Allow the detergent to “soak in” for 3-5 minutes before washing and rinsing. Reapply as needed to prevent surface from drying.
- For washing, start at lower portion of area to be washed and work upward, using long, even, overlapping strokes.

## Pressure Washer Rinsing



**WARNING!** Be extremely careful if you must use the pressure washer from a ladder, scaffolding or any other relatively unstable location. Pressure in a running washer builds as you climb. When you press the trigger, the recoil from the initial spray could cause you to fall. The high pressure spray could also cause you to fall if you are too close to the cleaning surface.

### For Rinsing:

- Slide the nozzle backward to high pressure, press the trigger and wait for the detergent to clear.

**NOTE:** You can also stop detergent from flowing by simply removing detergent siphoning tube from bottle.

- Keep the spray gun a safe distance from the area you plan to spray.
- Apply a high pressure spray to a small area, then check the surface for damage. If no damage is found, it is okay to continue cleaning.
- Start at the top of the area to be rinsed, working down with same overlapping strokes as you used for washing and applying detergent.

## Automatic Cool Down System (Thermal Relief)

If you run the engine on your pressure washer for 3-5 minutes without pressing the trigger on the spray gun, circulating water in the pump can reach a temperature between 140–145°F. When the water reaches this temperature, the automatic cool down system engages and cools the pump by **discharging the warm water onto the ground**. This system prevents internal damage to the pump.

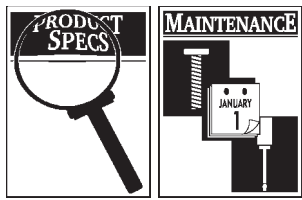

## SPECIFICATIONS

- Outlet Pressure.** . . . . . 2,400 psi
- Flow Rate.** . . . . . 2.2 gallons per minute (gpm)
- Detergent.** . . . . . Use detergent approved for pressure washers
- Water Supply Temp.** . . . Not to Exceed 140°F
- Automatic Cool Down System** . . . . . Will cycle when water reaches 140°-145°F

## GENERAL MAINTENANCE RECOMMENDATIONS

The pressure washer warranty does not cover items that have been subjected to operator abuse or negligence. To receive full value from the warranty, the operator must maintain the high pressure washer as instructed in this manual.

- Some adjustments will need to be made periodically to properly maintain your high pressure washer.
- All maintenance in this manual and the engine owner’s manual should be made at least once each season.
- Once a year you should clean or replace the spark plug, clean or replace the air filter and check the gun and adjustable nozzle extension assembly for wear. A new spark plug and clean air filter assure proper fuel-air mixture and help your engine run better and last longer. Please refer to your engine owner’s manual for more details.

### BEFORE EACH USE

- Check engine oil level.
- Check water inlet screen for damage.
- Check high pressure hose for cracks or leaks.
- Check detergent siphoning tube and filter for damage.
- Check gun and adjustable nozzle extension assembly for leaks.
- Rinse out garden hose to flush out debris **before** it is attached to the pump.

## PRESSURE WASHER MAINTENANCE

### Check and Clean Inlet Screen

Examine the screen on the water inlet. Clean it if the screen is clogged or replace it if screen is damaged.

### Check High Pressure Hose

The high pressure hose can develop leaks from wear, kinking, or abuse. Inspect the hose each time before using it. Check for cuts, leaks, abrasions or bulging of cover, damage or movement of couplings. If any of these conditions exist, replace the hose immediately.

**WARNING!** Water spraying from a leak is capable of injecting material into skin. Inspect hose each time before using it. **Never** repair a high pressure hose. Replace it with another hose that exceeds the maximum pressure rating of your pressure washer.

### Check Detergent Siphoning Tube

Examine the filter on the detergent tube and clean if clogged. The tube should fit tightly on the barbed fitting. Examine the tube for leaks or tears. Replace the filter or tube if either is damaged.

### Check In-Line Filter

Refer to Figure 17 and service the in-line filter if it becomes clogged, as follows:

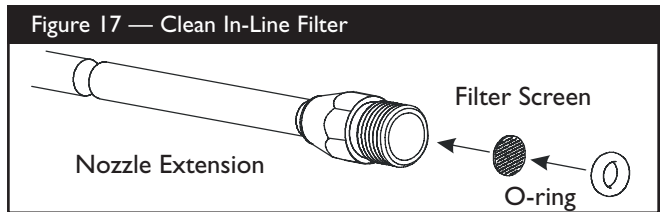

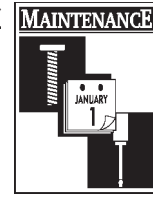

1. Detach gun and nozzle extension from high pressure hose. Detach nozzle extension from gun and remove o-ring and screen from nozzle extension. Flush the screen, gun, and adjustable nozzle extension with clean water to clear debris.
2. If the screen is damaged, the o-ring kit contains a replacement in-line filter screen and an o-ring. If undamaged, reuse screen.
3. Place the in-line filter screen into the threaded end of the nozzle extension. Direction does not matter. Push the screen in with the eraser end of a pencil until it rests flat at the bottom of the opening. Take care to not bend the screen.
4. Place the o-ring into the recess. Push the o-ring snugly against the in-line filter screen.
5. Assemble the nozzle extension to the spray gun, as described earlier in this manual.

## Check Gun and Nozzle Extension

Examine the hose connection to the gun and make sure it is secure. Test the trigger by pressing it and making sure it “springs back” into place when you release it. Put the safety latch in the ON position and test the trigger. You should not be able to press the trigger.

## Purge Pump of Air and Contaminants

**To remove air from the pump, follow these steps:**

- Set up the pressure washer as described in “Preparing Pressure Washer For Use” (page 5). Connect the water supply and turn water ON.
- Pull the trigger on the gun and hold.
- When the water supply is steady and constant, engage the safety latch.

**To remove contaminants from the pump, follow these steps:**

- Set up the pressure washer as described in “Preparing Pressure Washer For Use” (page 5). Connect the water supply and turn water on.
- Start the engine using instructions given earlier in this manual.
- Squeeze the trigger on the gun and hold.

- When the water stream is steady and constant, engage the safety latch and attach the nozzle extension.

## Cleaning Detergent Siphoning Tube

If you used the detergent siphoning tube, you must flush it with clean water before stopping the engine.

- Place the detergent siphoning tube in a bucket full of clean water.
- Slide the adjustable nozzle forward to the low pressure position. Flush for 1-2 minutes.
- Shut off the engine.

**IMPORTANT:** Simply shutting OFF engine will not release pressure in the system. **When the engine has shut down, squeeze the trigger on the gun to relieve the pressure in the hose.**

## Nozzle Maintenance

If a nozzle becomes restricted or clogged with dirt or foreign materials, a pulsing sensation caused by excessive pump pressure may occur during use.

Immediately clean a clogged or partially restricted nozzle with the kit included with your pressure washer by following these instructions:

- Shut off the engine and turn off the water supply.
- Disengage the safety latch and pull the trigger on the spray gun. Hold until all water is purged from the unit. Engage the safety latch on the spray gun.
- Separate the nozzle extension from the spray gun.
- Twist nozzle to stream setting.
- Remove nozzle from the end of the nozzle extension using a 2 mm or 5/64 allen wrench (included in Nozzle Cleaning Kit) (Figure 18).

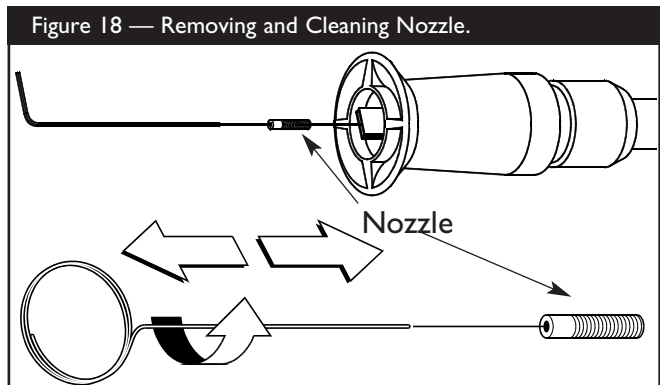



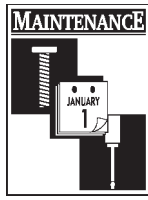

- Use the wire included in the kit or a small paper clip to free the foreign materials clogging or restricting the nozzle (Figure 18).
- Remove additional debris by back flushing water supply through nozzle extension. Back flush between 30 to 60 seconds. Twist nozzle extension to stream pattern and move nozzle from low to high pressure while flushing (Figure 19).

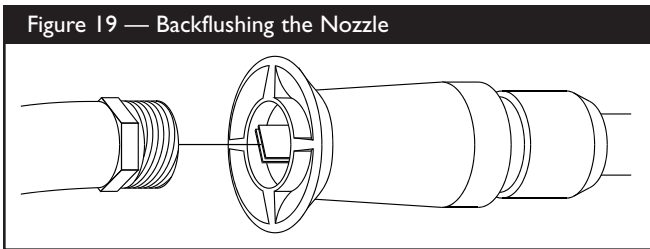

- Reinstall nozzle into nozzle extension. Do Not overtighten.
- Reconnect the water supply, turn ON the water, and start the engine.
- Reconnect nozzle extension to spray gun.
- Test the pressure washer by operating with nozzle in the high and the low pressure positions.

## O-Ring Maintenance

Your pressure washer uses o-rings to keep hose and spray gun connections tight and leak-free. Through the normal operation of your unit, these o-rings may become worn or damaged.

Provided with your pressure washer is an O-Ring Maintenance Kit which includes replacement o-rings, rubber washer and water inlet filter. Refer to the instruction sheet provided in the kit to service your unit's o-rings. Note that not all of the parts in the kit will be used on your unit.

### To remove a worn or damaged o-ring:

- Use a small flathead screwdriver to get underneath the o-ring and pry it off.

## ENGINE MAINTENANCE

See the engine owner's manual for instructions on how to properly maintain the engine.

**OIL CHANGE NOTE:** It is necessary to tip your pressure washer when changing engine oil. Avoid spilling oil on pump when changing engine oil. Wipe up any spilled oil promptly.

## PREPARING THE UNIT FOR STORAGE

Water should not remain in the unit for long periods of time. Sediments or minerals can deposit on pump parts and "freeze" pump action. If you do not plan to use the pressure washer for more than 30 days, follow this procedure:

1. Flush detergent siphoning tube by placing the filter into a pail of clean water while running pressure washer in low pressure mode (adjustable nozzle in the forward position). Flush for one to two minutes.
2. Shut off the engine and let it cool, then remove all hoses. Disconnect spark plug wire from spark plug.
3. Empty the pump of all pumped liquids by pulling the recoil handle about 6 times. This should remove most of the liquid in the pump.

**NOTE:** To protect the unit from freezing temperatures, draw RV antifreeze (non-alcohol) into the pump by pouring the solution into a 3-foot section of garden hose connected to inlet adapter and pulling recoil handle twice.

4. Store unit in a clean, dry area.

## STORING THE ENGINE

See the engine owner's manual for instructions on how to properly prepare the engine for storage.



## TROUBLESHOOTING

Problem	Cause	Correction
<b>Pump has following problems: failure to produce pressure, erratic pressure, chattering, loss of pressure, low water volume.</b>	<ol style="list-style-type: none"> <li>1. Nozzle in low pressure mode.</li> <li>2. Water inlet is blocked.</li> <li>3. Inadequate water supply.</li> <li>4. Inlet hose is kinked or leaking.</li> <li>5. Clogged inlet hose strainer.</li> <li>6. Water supply is over 140°F.</li> <li>7. High pressure hose is blocked or leaks.</li> <li>8. Gun leaks.</li> <li>9. Nozzle is obstructed.</li> <li>10. Pump is faulty.</li> </ol>	<ol style="list-style-type: none"> <li>1. Pull nozzle backward for high pressure mode.</li> <li>2. Clear inlet.</li> <li>3. Provide adequate water flow.</li> <li>4. Straighten inlet hose, patch leak.</li> <li>5. Check and clean inlet hose strainer.</li> <li>6. Provide cooler water supply.</li> <li>7. Clear blocks in outlet hose.</li> <li>8. Replace gun.</li> <li>9. Clean nozzle.</li> <li>10. Contact Generac service facility.</li> </ol>
<b>Detergent fails to mix with spray.</b>	<ol style="list-style-type: none"> <li>1. Detergent siphoning tube is not submerged.</li> <li>2. Chemical filter is clogged.</li> <li>3. Nozzle is in high pressure mode.</li> </ol>	<ol style="list-style-type: none"> <li>1. Insert detergent siphoning tube into detergent.</li> <li>2. Clean or replace filter/detergent siphoning tube.</li> <li>3. Push nozzle forward for low pressure mode.</li> </ol>
<b>Engine runs good at no-load but “bogs” when load is added.</b>	Engine speed is too slow.	Move throttle control to FAST position. If engine still “bogs down”, contact Briggs service facility.
<b>Engine will not start; or starts and runs rough.</b>	<ol style="list-style-type: none"> <li>1. Low oil level.</li> <li>2. Dirty air cleaner.</li> <li>3. Out of gasoline.</li> <li>4. Stale gasoline.</li> <li>5. Spark plug wire not connected to spark plug.</li> <li>6. Bad spark plug.</li> <li>7. Water in gasoline.</li> <li>8. Overchoking.</li> <li>9. Excessively rich fuel mixture.</li> <li>10. Intake valve stuck open or closed.</li> <li>11. Engine has lost compression.</li> </ol>	<ol style="list-style-type: none"> <li>1. Fill crankcase to proper level.</li> <li>2. Clean or replace air cleaner.</li> <li>3. Fill fuel tank.</li> <li>4. Drain gas tank; fill with fresh fuel.</li> <li>5. Connect wire to spark plug.</li> <li>6. Replace spark plug.</li> <li>7. Drain gas tank; fill with fresh fuel.</li> <li>8. Open choke fully and crank engine.</li> <li>9. Contact Briggs service facility.</li> <li>10. Contact Briggs service facility.</li> <li>11. Contact Briggs service facility.</li> </ol>
<b>Engine shuts down during operation.</b>	<ol style="list-style-type: none"> <li>1. Out of gasoline.</li> <li>2. Low oil level.</li> </ol>	<ol style="list-style-type: none"> <li>1. Fill fuel tank.</li> <li>2. Fill crankcase to proper level.</li> </ol>
<b>Engine lacks power.</b>	Dirty air filter.	Replace air filter.
<b>Engine “hunts” or falters.</b>	Choke is opened too soon.	Move choke to halfway position until engine runs smoothly.

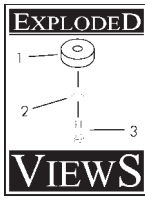

# EXPLODED VIEW — UNIT

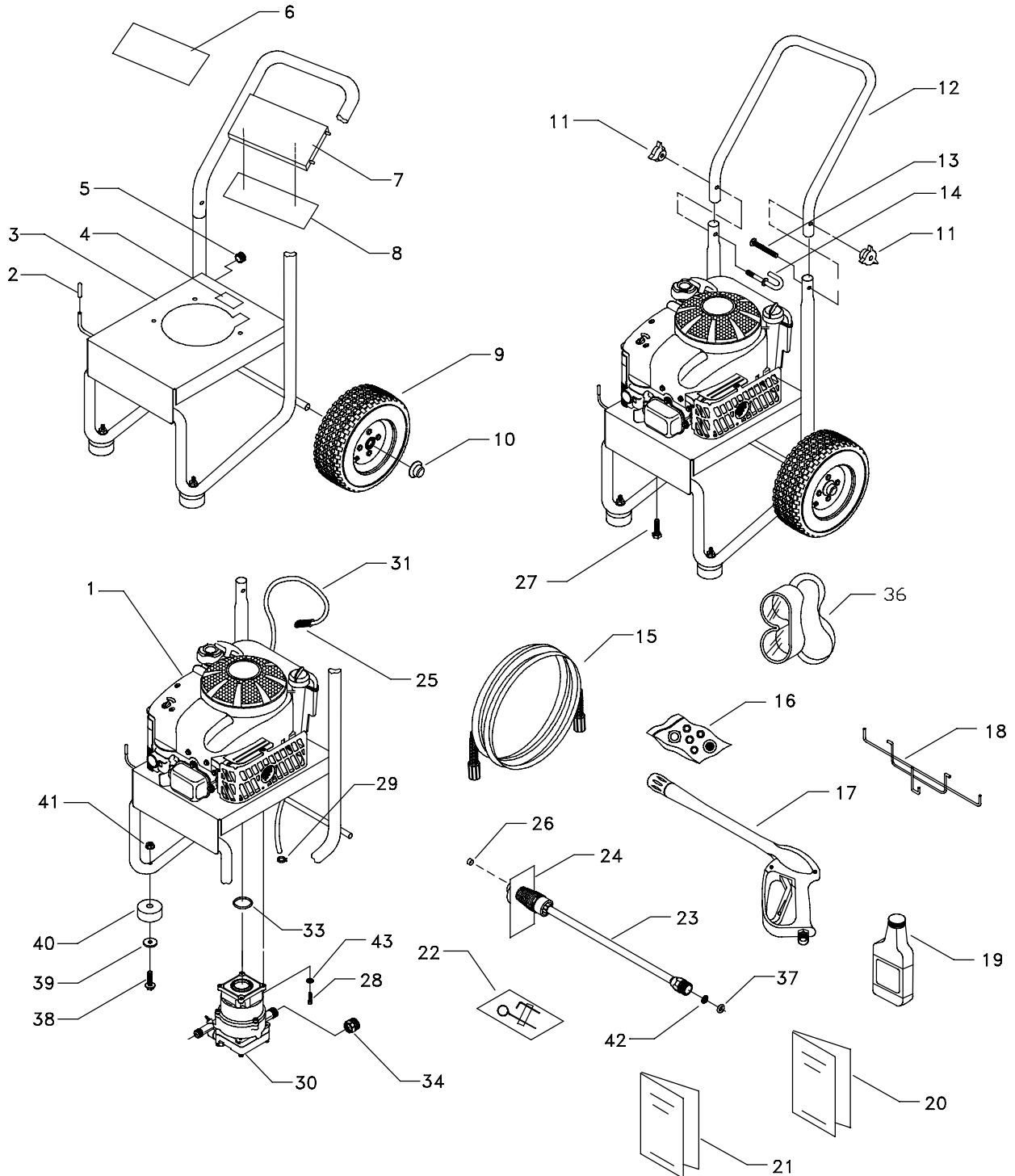

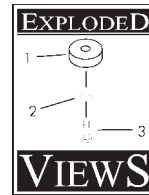

## PARTS LIST — UNIT

Item	Part #	Qty.	Description
1	NSP	1	ENGINE
2	B1460	1	CAP, Vinyl Black
3	AB5737	1	BASE, Powder Coat Red
4	20566	1	DECAL, 1-800 Number
5	30809	1	GROMMET, Chem Hose
6	B5744	1	DECAL, Logo 2400 PSI
7	B1631B	1	BILLBOARD, Plastic
8	B1932	1	DECAL, Instructions
9	B4966	2	WHEEL, 3 X 10"
10	75402C	2	PUSHNUT, 5/8"
11	97178	2	KNOB, PW Handle
12	AB1945	1	HANDLE, Powder Coat Red
13	31669	1	BOLT, 1/4"-20 X 1.75" Carriage
14	B1730	1	BOLT, Eye
15	B5642	1	HOSE, 1/4" X 25'
16	B5830	1	KIT, O-Ring Maintenance
17	B3263	1	GUN, High Pressure
18	B1953A	1	WIREFORM
19	BB3061B	1	OIL, 20oz
20	B5740	1	MANUAL, Owners
21	B5765	1	MANUAL, B & S Engine
22	B2163	1	KIT, Nozzle Cleaning
23	B3335	1	WAND, Adjustable Nozzle
24	97566	1	HANG TAG, Nozzle
25	A1041	1	FILTER, Chemical Hose
26	21761	1	NOZZLE, 1.05 Yellow Rplcemt
27	75246	3	TAPTITE, 3/8" - 16 x 1-1/4"
28	23707	4	SHCS, 5/16" - 24 x 1"
29	48031G	1	CLAMP, Hose
30	B4925A	1	PUMP, Assembly
31	A1040B	1	HOSE, Chemical
33	B2218	1	O-RING, 1.625" ID x .103"
34	21424	1	CONNECTOR, Garden Hose
36	87815	1	GLASSES, Safety
37	97837	1	O-RING, Hi-Pressure
38	B1214	2	HHCS, M8 X 1.25 X 45
39	50190	2	WASHER, Flat, .34" x 1"
40	27007	2	MOUNT, Rubber Foot
41	52858	2	NUT, M8 Locking Flange
42	B4224	1	SCREEN, Gun Inlet
43	92479	4	WASHER, M8 Conical Ribbed

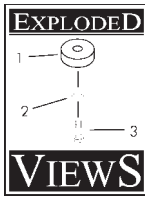

# EXPLODED VIEW — PUMP

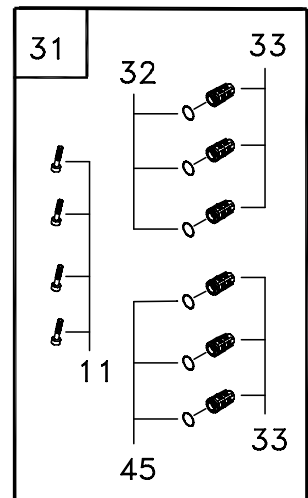
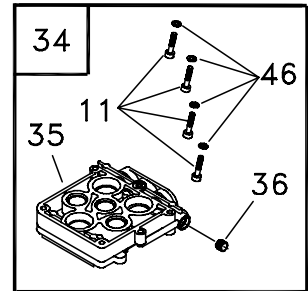
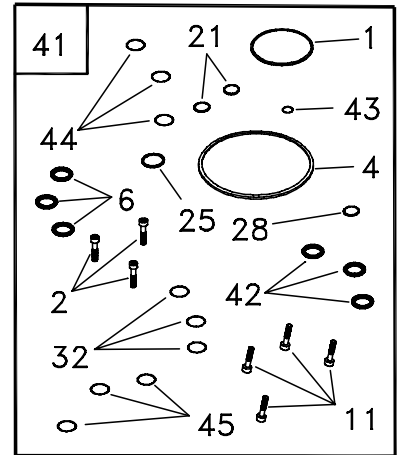
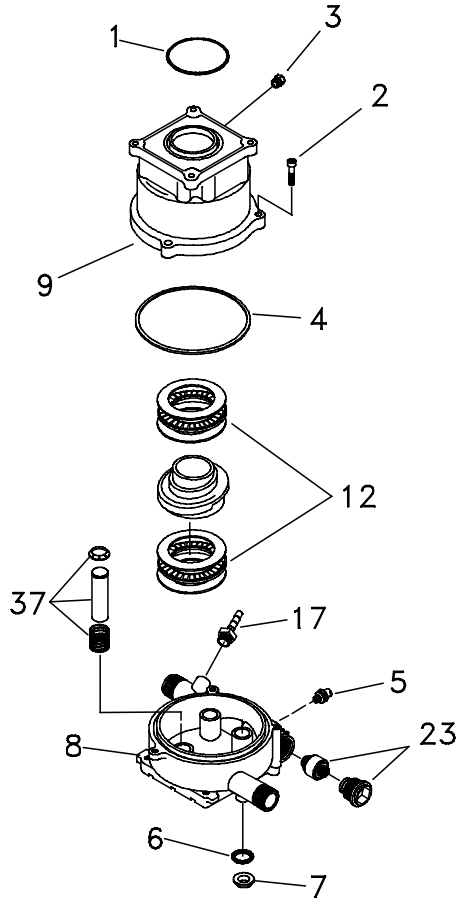
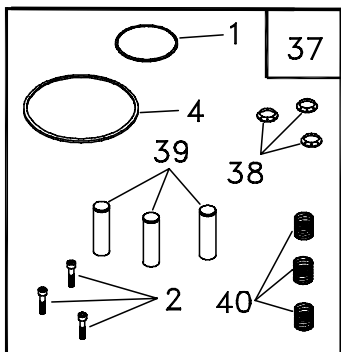
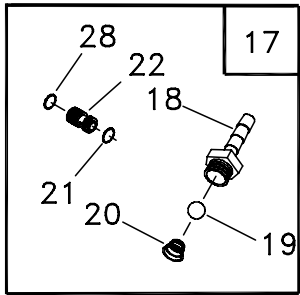
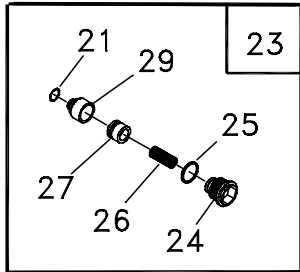
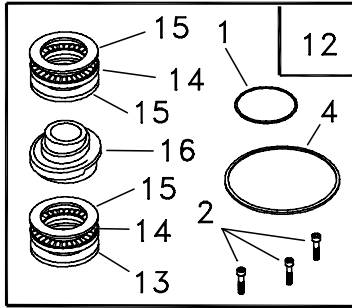



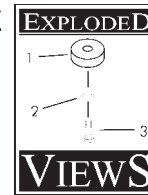

## PARTS LIST — PUMP

Item	Part #	Qty.	Description	Item	Part #	Qty.	Description
1	B2218	1	O-RING, 1.625 ID x .103	31	185712	0	<b>KIT, CHECK VALVES</b>
2	97962	3	SHCS, M6 - 1 x 25	11	.....	4	SHCS, M6-1.0 x 35
3	B5710	1	VALVE, 1/8 npt 1-5 PSI	32	.....	3	O-RING, Check Valve
4	97835	1	O-RING, Housing Seal	33	.....	6	ASSY., Check Valve
5	21783	1	THERMAL RELIEF, GPW-EG	45	.....	3	O-RING, Check Valve, White
6	93680	3	SEAL, Oil Piston	34	185531	0	<b>KIT, HEAD BRASS EG</b>
7	97831	3	SPACER, Pilot	11	.....	4	SHCS, M6-1.0 x 35
8	B2702	1	HOUSING, Piston	35	.....	1	HEAD, Pump
9	B4813	1	ADAPTER, Engine	36	.....	1	PLUG, 1/8-28
10	97841	3	CAP, Outlet Check Valve	46	.....	4	WASHER, M6 Flat
11	40946	4	SHCS, M6-1.0 x 35	37	185713	0	<b>KIT, PISTON &amp; SPRING</b>
12	185710	0	<b>KIT, AXIAL CAM</b>	1	.....	1	O-RING, Engine Seal
1	.....	1	O-RING, Engine Seal	2	.....	3	SHCS, M6 - 1 x 25
2	.....	3	SHCS, M6 - 1 x 25	4	.....	1	O-RING, Housing Seal
4	.....	1	O-RING, Housing Seal	38	.....	3	RETAINER, Piston Spring
13	.....	1	WASHER, Brg. 36 x 65 x 6Thk	39	.....	3	PISTON, Dia. 15 x 65
14	.....	2	ASSY., Brg. Cage 45 x 65	40	.....	3	SPRING, Piston Return
15	.....	3	WASHER, Brg. 45 x 65 x 1	41	185714	0	<b>KIT, O-RING/SEAL 2300</b>
16	.....	1	CAM, Axial 5.6 7/8"SAE	1	.....	1	O-RING, Engine Seal
17	185287	0	<b>KIT, CHEM INJECT</b>	2	.....	3	SHCS, M6 - 1 x 25
18	.....	1	FITTING, Chem Inject	4	.....	1	O-RING, Housing Seal
19	.....	1	BALL, Chem Inject	6	.....	3	SEAL, Oil Piston
20	.....	1	SPRING, Chem Inject	11	.....	4	SHCS, M6-1.0 x 35
21	.....	1	O-RING, Venturi & Seat, Black	21	.....	2	O-RING, Venturi & Seat, Black
22	.....	1	VENTURI, Chem Inject	25	.....	1	O-RING, Unloader Cap
28	.....	1	O-RING, Venturi, Yellow	28	.....	1	O-RING, Venturi, Yellow
23	185711	0	<b>KIT, UNLOADER 2300</b>	32	.....	3	O-RING, Check Valve
21	.....	1	O-RING, Venturi & Seat, Black	42	.....	3	SEAL, Double-Lip
24	.....	1	CAP, Unloader	43	.....	1	O-RING, High Pressure Transfer
25	.....	1	O-RING, Unloader Cap	44	.....	3	O-RING, Outlet CV Cap
26	.....	1	SPRING, Unloader	45	.....	3	O-RING, Check Valve, White
27	.....	1	PISTON, Unloader				
29	.....	1	SEAT, Unloader				

Item numbers 12, 17, 23, 31, 34, 37, and 41 are service kits and include all parts shown within the box. Certain parts may only be available as components of a kit.

# LIMITED PRESSURE WASHER WARRANTY

GENERAC PORTABLE PRODUCTS (hereafter referred to as the COMPANY) warrants to the original retail purchaser the pressure washer manufactured by the COMPANY to be free from defects in material and workmanship for the period(s) set forth below from the date of original purchase. This warranty is not transferable. The term "original purchaser" means the person for whom the pressure washer is originally purchased.

## Warranty Schedules

Electric Power Washer	<b>1 year</b> (does not apply to commercial or rental applications)		
		CONSUMER*	COMMERCIAL*
All Other Engine-driven	<b>Engine:</b>	Warranted solely by Engine Manufacturer	Warranted solely by Engine Manufacturer
	<b>Pump:</b>	<b>1 year</b>	<b>90 days</b>

**\* NOTE: For the purpose of this warranty, "consumer" use means personal residential household use by original purchaser. "Commercial" use means all other uses, including rental, construction, commercial and income producing purposes. Once a pressure washer has experienced commercial use, it shall thereafter be considered a commercial use pressure washer for the purposes of this warranty.**

During said warranty period, the COMPANY will, at its option, repair or replace any part which, upon examination by the COMPANY or COMPANY-authorized dealers, is found to be defective under normal use and service\*\*. All transportation costs under warranty, including return to the factory if necessary, are to be borne by the purchaser and prepaid by the purchaser.

**\*\* NORMAL WEAR: As with all mechanical devices, pressure washers need periodic parts service and replacement to perform well. This warranty does not cover repair when normal use has exhausted the life of a part or pressure washer pump.**

**This warranty does not include:** Used products and demonstration equipment. Parts, such as GUNS, HOSES, NOZZLE EXTENSIONS, NOZZLES or other wear items such as quick couplers, oil, gauges, belts, o-rings, filters, pump packing, etc. Pumps which have been run without water supplied. Damage or malfunctions resulting from accidents, abuse, modifications, alterations, or improper servicing. Freezing or chemical deterioration. Normal maintenance such as adjustments, fuel system cleaning and obstruction (due to chemical, dirt, carbon or lime, etc.).

THIS WARRANTY IS IN PLACE OF ALL OTHER WARRANTIES, EXPRESS OR IMPLIED, SPECIFICALLY, THE COMPANY MAKES NO OTHER WARRANTIES AS TO MERCHANTABILITY OR FITNESS FOR A PARTICULAR PURPOSE. THE DURATION OF ANY IMPLIED WARRANTIES WHICH CANNOT BE DISCLAIMED IS LIMITED TO THE TIME PERIOD AS SPECIFIED IN THE EXPRESS WARRANTY. LIABILITY FOR CONSEQUENTIAL, INCIDENTAL, OR SPECIAL DAMAGES UNDER ANY AND ALL WARRANTIES IS EXCLUDED, EVEN IF SUCH DAMAGES ARE A DIRECT RESULT OF THE COMPANY'S NEGLIGENCE. THE COMPANY ALSO DISCLAIMS ANY RESPONSIBILITY FOR INCIDENTAL OR CONSEQUENTIAL DAMAGES, SUCH AS THE LOSS OF TIME OR THE USE OF THE POWER EQUIPMENT, OR ANY COMMERCIAL LOSS DUE TO THE FAILURE OF THE EQUIPMENT. ANY IMPLIED WARRANTIES ARE LIMITED TO THE DURATION OF THIS WRITTEN WARRANTY.

Some states do not allow limitations on how long an implied warranty lasts, or the exclusion or limitation of incidental or consequential damages, so the above limitations or exclusions may not apply to you. This warranty gives you specific legal rights and you may also have other rights, which vary from state to state.

For service, see your nearest COMPANY-authorized warranty service facility or call 1-877-544-0982. Warranty service can be performed only by a COMPANY-authorized service facility. This warranty will not apply to service at any other facility. At the time of requesting warranty service, evidence of original purchase date must be presented.

**Generac Portable Products**

Jefferson, Wisconsin U.S. A.